

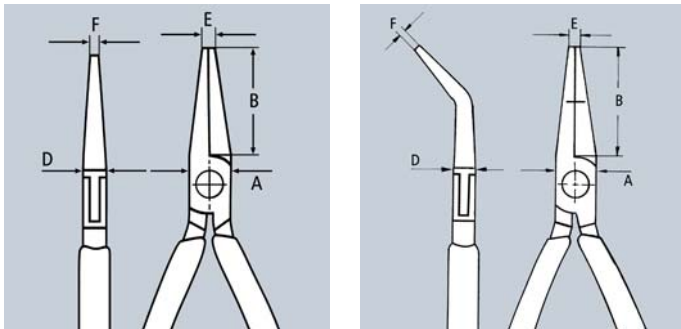





















## Electronics Pliers

DIN ISO 9655

35

- > precision pliers for fine assembly work, e.g. in electronics and fine mechanics
- > for gripping, holding and bending
- > sturdy, zero backlash box joint
- > smooth ground gripping surfaces
- > edges carefully deburred
- > low-friction double spring for gentle and even opening
- > the polish or mirror polish (only finish 2) together with a fine film of oil offer effective rust protection – no circuit faults caused by peeling chrome from plated tools
- > Special tool steel, forged, oil-hardened

35 11 115  
✳️    MM35 22 115  
✳️    MM35 32 115  
✳️ 8   MM35 42 115  
✳️  $\angle 45^\circ$     MM35 52 145  
✳️    MM35 62 145  
✳️    MM35 72 145  
✳️ 8   MM35 82 145  
✳️  $\angle 45^\circ$     MM

Article No.	EAN 4003773-	↔ mm		Head	Handles	Dimensions					 g
						B mm	A mm	D mm	E mm	F mm	
35 11 115	016694	115		mirror polished	plastic coated	22.5	9.5	6.5	2.0	4.0	61
35 12 115	035107	115		mirror polished	with multi-component grips	22.5	9.5	6.5	2.0	4.0	72
35 21 115	016724	115		mirror polished	plastic coated	22.5	9.5	6.5	2.0	1.5	59
35 22 115	035114	115		mirror polished	with multi-component grips	22.5	9.5	6.5	2.0	1.5	73
35 31 115	016762	115		mirror polished	plastic coated	22.5	9.5	6.5	2.0	1.0	58
35 32 115	035121	115		mirror polished	with multi-component grips	22.5	9.5	6.5	2.0	1.0	72
35 42 115	040736	115		mirror polished	with multi-component grips	22.5	9.5	6.5	2.0	1.5	74
35 52 145	039389	145		mirror polished	with multi-component grips	40.0	12.0	7.5	1.5	4.0	102
35 62 145	039556	145		mirror polished	with multi-component grips	40.0	12.0	7.5	2.5	1.5	103
35 72 145	043607	145		mirror polished	with multi-component grips	40.0	12.0	7.5	2.5	1.3	98
35 82 145	039396	145		mirror polished	with multi-component grips	35.0	12.0	7.5	2.5	1.0	102